

LASVIT GLITTERS WALL SCONCE MANUAL^{CE}

by Gabriela Náhlíková

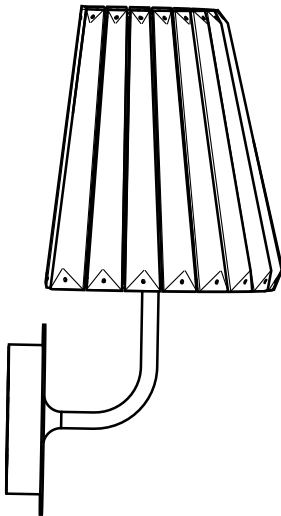

The Beauty Of Glass

EN

Contents

Technical parameters	1
Step-by-step installation	2
Uninstallation of the cover	3
Fixing point preparation	4
Fixing	5
Electrical wiring	6
Installation of the cover	7
Light source installation	8
Light source replacement	9
Warranties and Warranty Terms and Conditions	10

Markings

 Warning

Warns you of high risk of damage to the fixture or injury.

 Risk of electrical injury.

Warns you of high risk of electrical injury should a live part be directly or indirectly touched.

 Notice

Warns you about possible damage to the fixture.

 Important

Important information regarding the usage of your fixture.

 Note

Gives you general information about the usage of your fixture.

Please read this manual carefully and keep it in case you need assistance while performing maintenance and cleaning procedures.

1/ Technical parameters

Item ID / CL001WA-1CE

Light source / 1 × E14

Input voltage / 220 – 240 V, 50/60 Hz

Rated power / max. 40W

Protection rating / IP 20

Safety class / CLASS I

Dimensions / L 230 x H 205 x OH 350 x Projection 225 mm

Weight / approx. 3 kg

2/ Step-by-step installation

 Before starting any procedures make sure that the power cable of the lamp is disconnected from the socket, power is switched OFF and secured against unauthorized, negligent or accidental switching on.

 If the power cable of the luminaire is damaged, it shall be replaced by the manufacturer or a similar qualified person only in order to prevent any damage to health or property.

 To retain quality of hand-blown glass, Lasvit recommends to clean the glass at least every 3 months.

 The manufacturer shall not be held liable for any defects caused by unqualified handling of the lamp.

 Do not cover the lamp with any material, it is necessary for the hot parts to be cooled by freely flowing air, otherwise there is a risk of fire.

 For indoor use only. Installation requires 1 persons.

3/ Uninstallation of the cover

Step 1

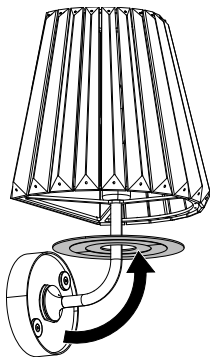

Step 2

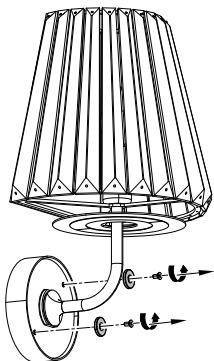

Step 3

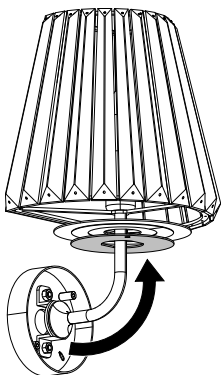

4/ Fixing point preparation

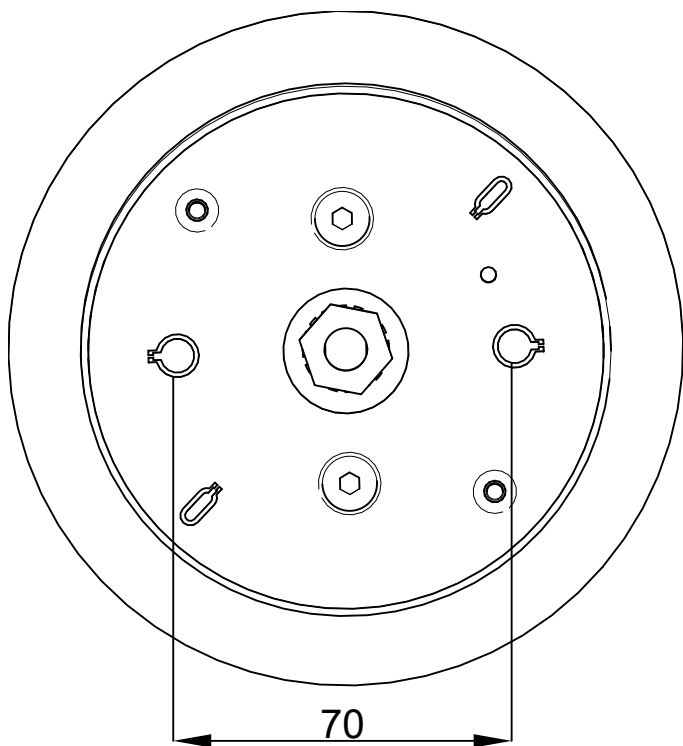

5/ Fixing

Fixing material is not included.

! Lasvit shall not be held liable for any injuries or damage to the fixture or other property caused during installation or by improper fixing. Consulting a specialist before choosing type of fixing materials and procedures for a given fixture is highly recommended.

Pictures shown are for illustration purposes only.

5.1/ Bolts/screws

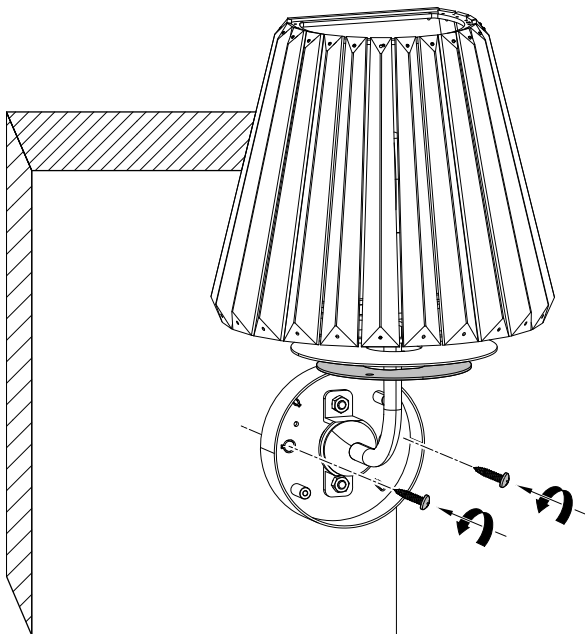

6/ Electrical wiring

Step 4

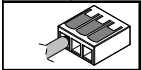
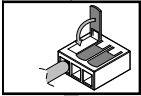
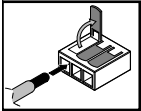
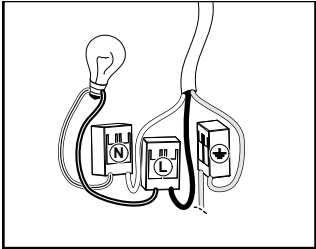

7/ Installation of the cover

Step 5

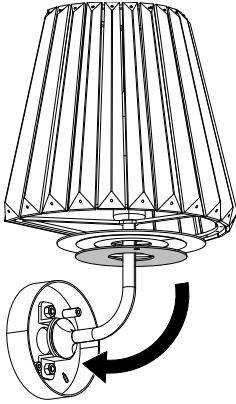

Step 6

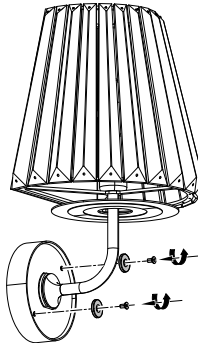

Step 7

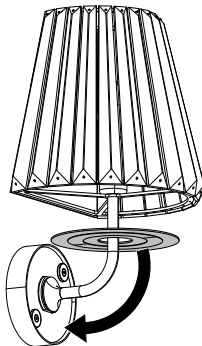

8/ Light source installation

Screw in the bulb clockwise.

Use E14 bulb with the following specifications: max 40W, 230V. The manufacturer shall not be held responsible for improper function when other light source is used.

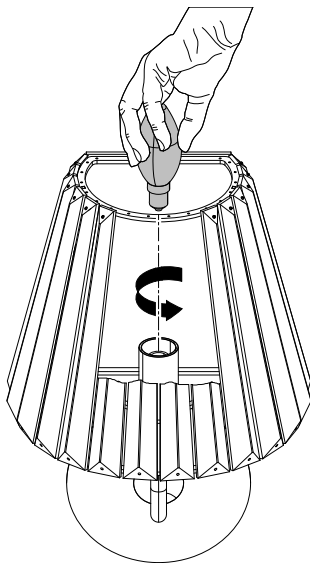

9/ Light source replacement

All light sources can be supplied by the manufacturer, Lasvit s.r.o.

Replacement of the bulb should be carried out by qualified technician to prevent damage to health or property.

Lasvit provides NO warranty on bulbs and is not responsible for any damage or injury caused during its installation or during its operation.

Before starting installation make sure the power to the lighting fixture is switched OFF and secured against unauthorized, negligent or accidental switching on.

The bulb can be very hot so wait at least 10 minutes until it has cooled down and there is no risk of injury. Unscrew the faulty bulb anticlockwise. Screw in the new bulb clockwise.

Use E14 bulb with the following specifications: max 40W, 230V.

The manufacturer shall not be held responsible for improper function when other light source is used.

Plug in the light again.

10/ Warranties and Warranty Terms and Conditions

1/ The warranty is defined in the Price Quotation, Price Agreement, Contract, or Order. If the Price Quote, contract, or order is not issued, the warranty does not apply to resources, maintenance, service and cleaning and the standard warranty on the goods is set for 2 years. Other agreed warranties must be specified in the Price Quotation, Price Agreement, Contract, or Order.

2/ As a basis for the claim, the customer must provide a valid contract, invoice, or other proof of payment. Otherwise, the manufacturer reserves the right to refuse to provide a warranty, so keep the proof of product purchase carefully.

3/ If the warranty applies to the defect found, the customer informs the seller by e-mail, telephone, or the Sales department of the manufacturer (Lasvit) and passes the required information (project number or light number, project or light name and describes the defect).

4/ The Sales Department proceeds on the basis of an internal customer complaint resolution directive.

5/ The manufacturer will analyse the occurrence of a disagreement with the customer or with the manufacturer after delivery of the non-conforming product to the manufacturer's premises.

6/ Once the analysis has been made, the Sales department is handed over the decision to accept or reject the complaint with an explanation.

7/ The Sales department agrees with the customer for further steps (e.g. repair or replacement date, etc. on the basis of customer and manufacturer possibilities). Unless otherwise agreed, the manufacturer is obliged to remove the defect within 30 days of the claim date at the manufacturer's expense.

8/ The warranty does not apply to:

- defects caused by the customer
- defects caused by a third party
- defects caused by regular usage
- defects caused by an installation contrary to the installation manual
- defects caused by inappropriate attachment or product connection
- defects caused by performed in contradiction with the cleaning manual

- defects caused by the use of other than defined light sources
- defects caused by installation in premises that do not correspond to the nature of the light and its IP cover (intrusion protection).
- defects caused by force majeure

9/ The company LASVIT has the exclusive right to grant, deny or change the terms and conditions for the provision of warranty services.







■ Never dispose of this product in mixed municipal waste, it must be submitted at the designated disposal installation.

The fixture was designed and manufactured by /
Lasvit s.r.o. / Komunardů 32 / 170 00 Praha 7 /
Czech Republic T +420 481 120 810 / F +420 481 120 622 /
E lasvit@lasvit.com lasvit.com

Manual created

01.07.2021

In case you need any assistance or have any suggestion, please contact us at

lasvit.com