

LASVIT GALAXY LUMINIA QUADRIX LENITAS MANUAL CE

by Bořek Šípek



The Beauty Of Glass

EN

Contents

Technical parameters	1
Step-by-step installation	2
Fixing point preparation	3
Canopy disassembly	4
Fixing	5
Electrical wiring	6
Installation of the glass component	7
Canopy mounting	9
Light source replacement	14
Installation notes	15
Warranties and Warranty Terms and Conditions	16

Markings

Warning

Warns you of high risk of damage to the fixture or injury.

Risk of electrical injury.

Warns you of high risk of electrical injury should a live part be directly or indirectly touched.

Notice

Warns you about possible damage to the fixture.

Important

Important information regarding the usage of your fixture.

Note

Gives you general information about the usage of your fixture.

Please read this manual carefully and keep it in case you need assistance while performing maintenance and cleaning procedures.

1/ Technical parameters

Item ID / Quadrix Lenitas CL011SC-2CE

Light source / 12x G4

Input voltage / 220 – 240 V, 50/60 Hz

Rated power / max. 24W

Protection rating / IP 20

Safety class / CLASS I

Dimensions / dia 1200 x H 2300mm

Weight / approx. 42,8 kg

2/ Step-by-step installation

 Before starting any procedures make sure that the power to the lighting fixture is switched OFF and secured against unauthorized, negligent or accidental switching on.

 Should the cable need to be shortened, ask a qualified technician (licensed electrician) to disconnect the cable, shorten it and reconnect it, detail instructions can be found in the chapter **Cable shortening**. The same applies to lengthening the cable, however a new, longer cable needs to be purchased separately. Lasvit shall not be held liable for any injuries or damage to the fixture or other property caused by unauthorised manipulation with the cable or its parts.

 To retain quality of hand-blown glass, Lasvit recommends to clean the glass at least every 3 months.

 Fixing material is not part of the lighting fixture kit. Refer to the relevant section of this manual for suitable fixing materials and components.

 Proper fixing shall be the responsibility of the customer.

 Installation and electrical wiring should be carried out by a qualified electrician to prevent any damage to health or property.

 The manufacturer shall not be held liable for any defects caused by unqualified handling of the lighting fixture.

 This lighting fixture is to be mounted on fire proof surfaces.

 Do not cover the lighting fixture with any material, it is necessary for the hot parts to be cooled by freely flowing air, otherwise there is a risk of fire.

 Do not spin the pendant ! Spinning the pendant may result in breaking of the suspension cable and/or electrical malfunction!

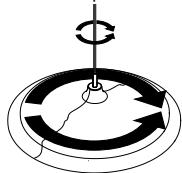

 For indoor use only. Installation requires 2 persons.

3/ Fixing point preparation

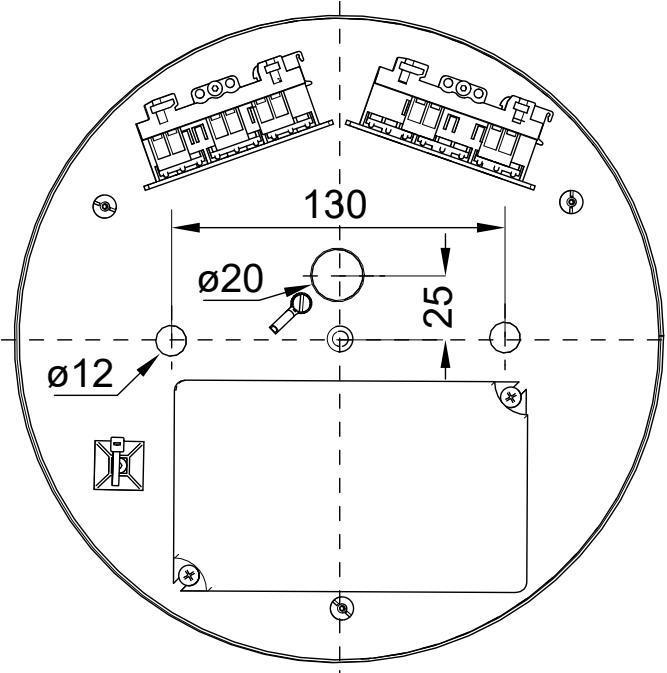

4/ Canopy disassembly

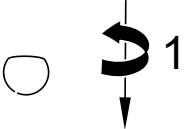
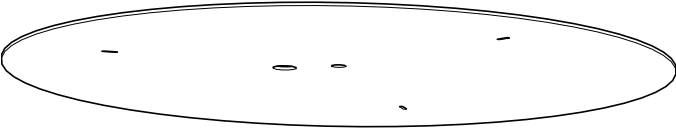
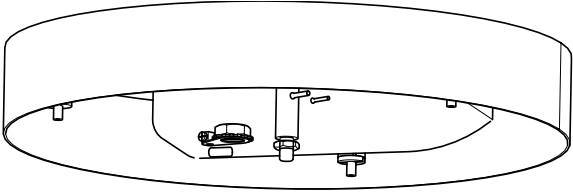

5/ Fixing

Fixing material is not included.

! Lasvit shall not be held liable for any injuries or damage to the fixture or other property caused during installation or by improper fixing. Consulting a specialist before choosing type of fixing materials and procedures for a given fixture is highly recommended.

Pictures shown are for illustration purposes only.

5.1/ Threaded rod

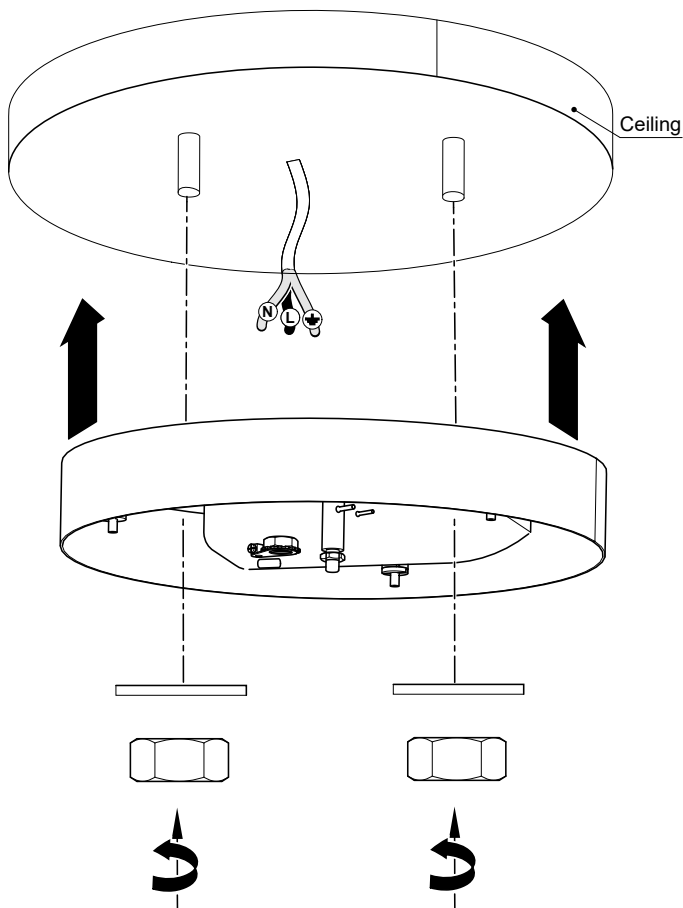

6/ Electrical wiring

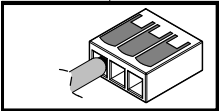
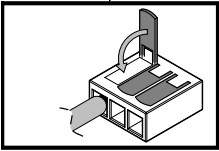
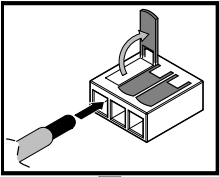
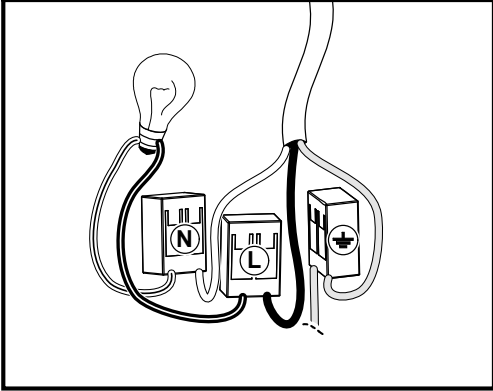

7/ Installation of the glass component

Pull the cord through the central hole in fixture body. Use mounting hole for fixing to put the cord holder cord and secure it on the place by tightening the screw in the holder clockwise.

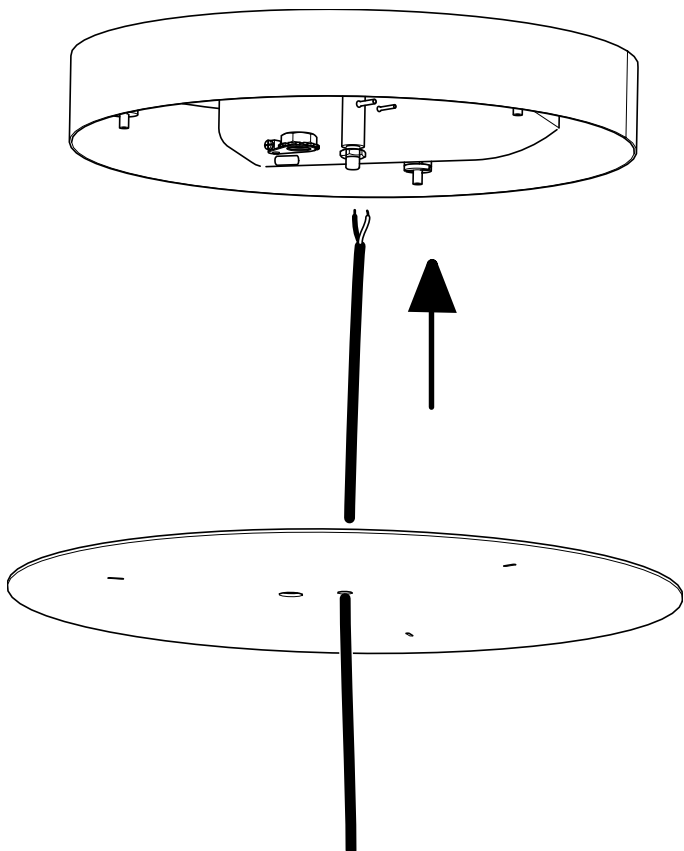

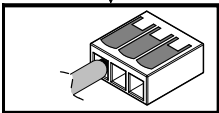
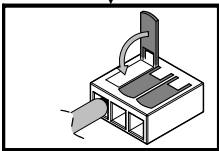
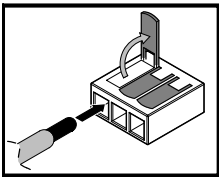
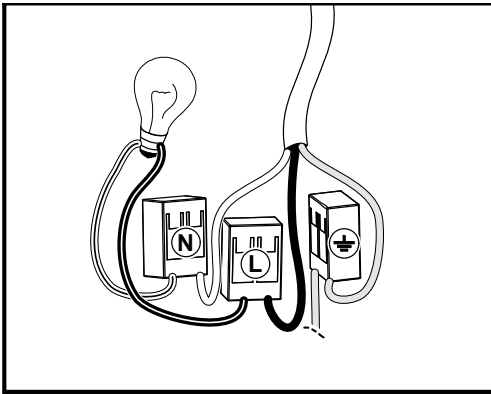

8/ Canopy mounting

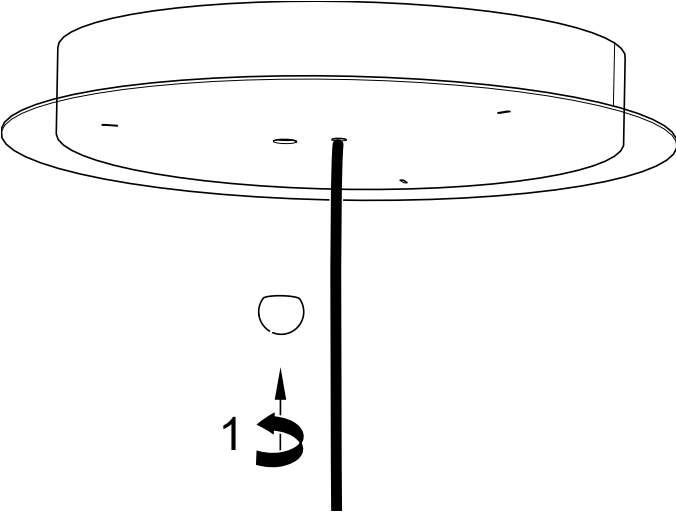

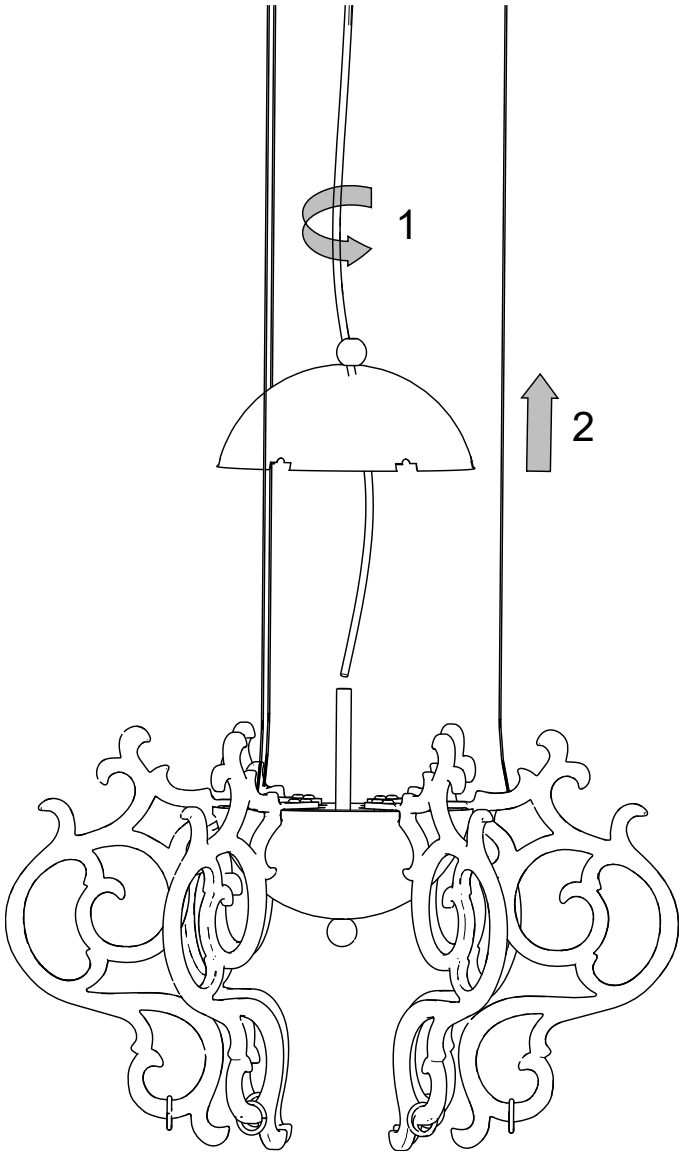

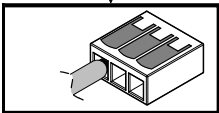
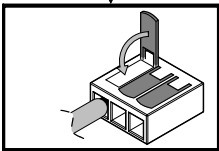
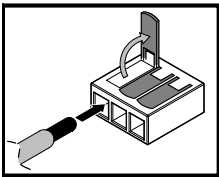
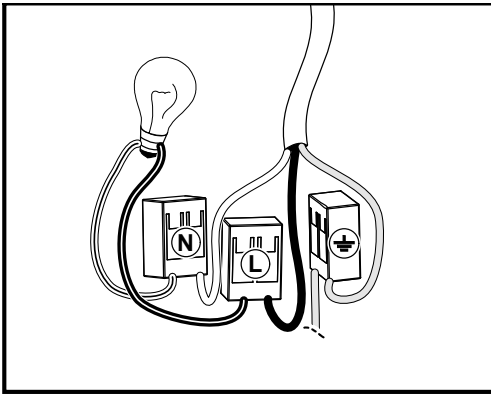

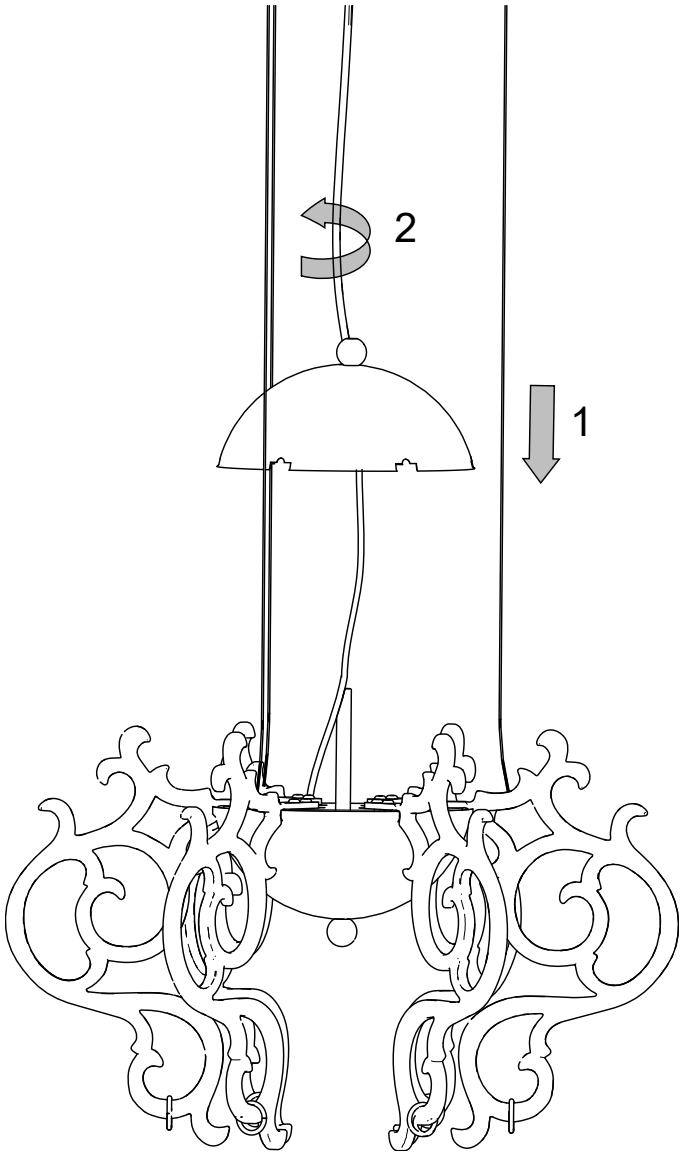

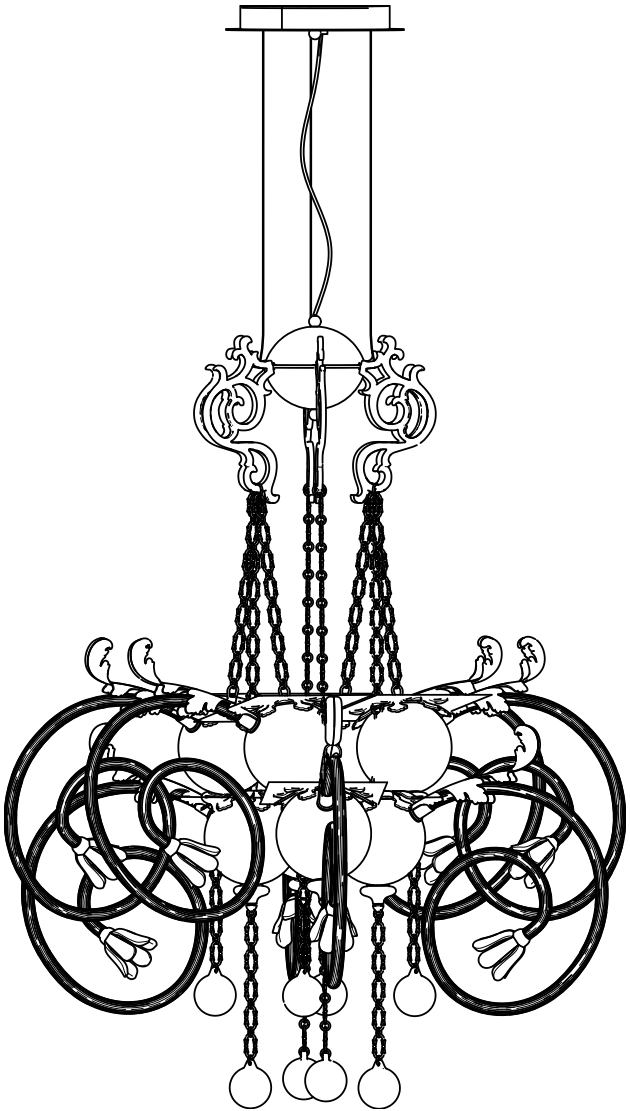

9/ Light source replacement

All light sources can be supplied by the manufacturer Lasvit s.r.o.

Replacement of the bulb should be carried out by qualified technician to prevent any damage to health or property. The bulb can be very hot so wait at least 10 minutes until it has cooled down and there is no risk of injury.

Unplug the light from the power grid.

Unscrew the faulty bulb anticlockwise. Screw in the new bulb clockwise. Use G4 bulb with the following specifications: max 24W, 230V.

The manufacturer shall not be held responsible for improper function when other light source is used.

Plug in the light again.

10/ Installation notes

10.1/ Cable shortening

 This adjustment can be carried out only by a qualified electrician (trained electrician).

 Perform the cable adjustment according to valid standards.

Picture 1: Adjusted cable from the manufacturer (LASVIT).

Picture 2: Shortening the cable to the desired length.

Picture 3: Remove only the top insulation. The basic insulation of the conductor must not be broken.

Picture 4: Final adjustment of the cable for its connection. Additional insulation (positions F, G), stripped ends of wires with tubes.

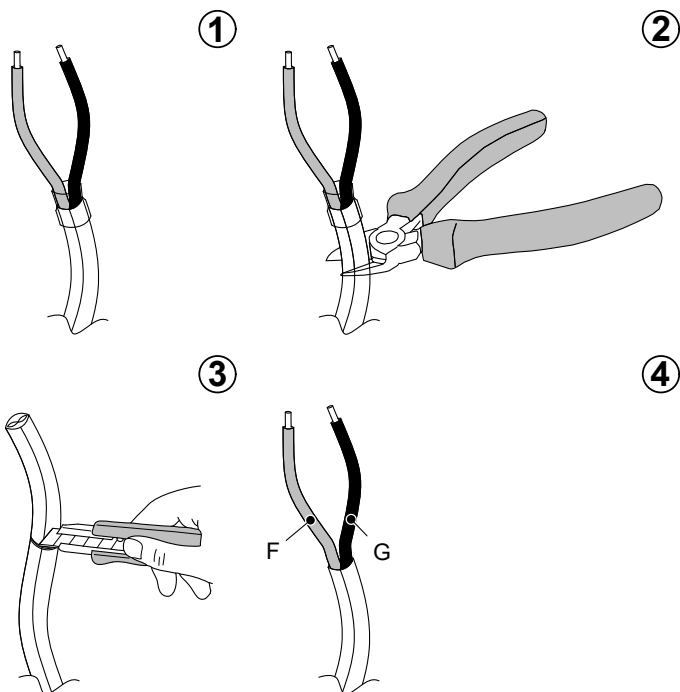

11/ Warranties and Warranty Terms and Conditions

1. The warranty is defined in Price Quotation (PQ) or in Purchase Agreement (PA). If **not stated otherwise**, the warranty shall not cover the **light sources**, maintenance, service and cleaning and the standard warranty shall be set at 2 years. Any other warranties must be specified in PQ or PA. The Customer must submit a valid agreement, invoice or another payment document as a base for any complaint.
2. If the warranty covers the detected defect, the Customer shall inform Sales (by e-mail or phone, defining the project / product number, the project / product name, the areas where the defect has emerged, and the sketch number. The Customer shall describe the defect).
3. Sales shall proceed based on the internal guideline for complaint management.
4. The Manufacturer shall analyze the origins of the defect either at the Customer's or at the Manufacturer's, after the defective product has been delivered to the Manufacturer's premises.
5. After the analysis, the decision about acknowledgement or refusal of the complaint and the respective explanation shall be passed on to Sales.
6. Sales shall submit information about acknowledgement / refusal of the complaint to the Customer within 7 workdays from reporting the defect at the latest. Sales shall agree further steps with the Customer (e.g. the date of repair, replacement, etc., based on the Customer's and Manufacturer's capacities). Unless agreed otherwise, the Manufacturer shall eliminate any defect within 30 days from the date of submittal of the complaint.
7. The complaints shall not cover any defects caused by the Customer, normal wear and tear, or by failure to follow the service manual or installation manual. The complaints shall not cover any defects caused by force majeure.
8. **The analysis may lead to the following conclusions:**

Manufacturer's fault:

- The product is repairable at the Customer's at the Manufacturer's cost.

- The product is repairable at the Manufacturer's at the Manufacturer's cost.
- The product is not repairable and shall be replaced by a tested functional one at the Manufacturer's cost.
- The product is not repairable and the Manufacturer cannot offer any replacement. The Manufacturer shall offer another product. The Customer shall accept the offer and settle the new product by a difference payment, or the Manufacturer shall pay a difference payment to the Customer.
- The product is not repairable and the Manufacturer cannot offer any replacement. The Manufacturer shall issue a refund to the Customer.

Customer's fault:

- The product is repairable at the Customer's at the Customer's cost.
- The product is repairable at the Manufacturer's at the Customer's cost.
- The product is not repairable and shall be replaced by a verified and functional one at the Customer's cost.
- The product is not repairable and the Manufacturer cannot offer any replacement. The Manufacturer may offer another product for purchase.











Never dispose of this product in mixed municipal waste, it must be submitted at the designated disposal installation.

The fixture was designed and manufactured by /
Lasvit s.r.o. / Komunardů 32 / 170 00 Praha 7 /
Czech Republic T +420 481 120 810 / F +420 481 120 622 /
E lasvit@lasvit.com lasvit.com

Manual created

20.09.2021

In case you need any assistance or have any suggestion, please contact us at

lasvit.com