

# LASVIT SPACEY ECLIPSE MANUAL<sup>UL</sup>

Spacey Collection  
by Lukáš Novák



The Beauty Of Glass

EN



# Contents

Technical parameters	1
Step-by-step installation	2
Canopy disassembly	3
Fixing point preparation	4
Fixing (J-Box)	5
Electrical wiring	6
Canopy mounting	9
Light source replacement	10
Installation notes	12
Cable shortening	13
Warranties and Warranty Terms and Conditions	15

## Markings

### Warning

Warns you of high risk of damage to the fixture or injury.

### Risk of electrical injury.

Warns you of high risk of electrical injury should a live part be directly or indirectly touched.

### Notice

Warns you about possible damage to the fixture.

### Important

Important information regarding the usage of your fixture.

### Note

Gives you general information about the usage of your fixture.

**Please read this manual carefully and keep it in case you need assistance while performing maintenance and cleaning procedures.**

# 1/ Technical parameters

Item ID / CL094PB-1UL

Color variants / lithyalin/opal

Light source / 1 × E26, max 25W

Input voltage / 120 V, 50/60 Hz

Rated power / max. 25 W

Protection rating / IP 20

Safety class / CLASS I

Dimensions / Ø 11<sup>3</sup>/<sub>4</sub> " x H 27<sup>1</sup>/<sub>2</sub> " x L "

Weight / approx. 12,1 lb

## 2/ Step-by-step installation

 Before starting any procedures make sure that the power to the lighting fixture is switched OFF and secured against unauthorized, negligent or accidental switching on.

 Should the cable need to be shortened, ask a qualified technician (licensed electrician) to disconnect the cable, shorten it and reconnect it. The same applies to lengthening the cable, however a new, longer cable needs to be purchased separately. Lasvit shall not be held liable for any injuries or damage to the fixture or other property caused by unauthorised manipulation with the cable or its parts.

 To retain quality of hand-blown glass, Lasvit recommends to clean the glass at least every 3 months.

 Fixing material is not part of the lighting fixture kit. Refer to the relevant section of this manual for suitable fixing materials and components.

 Proper fixing shall be the responsibility of the customer.

 Installation and electrical wiring should be carried out by a qualified electrician to prevent any damage to health or property.

 The manufacturer shall not be held liable for any defects caused by unqualified handling of the lighting fixture.

 This lighting fixture is to be mounted on fire proof surfaces.

 Do not cover the lighting fixture with any material, it is necessary for the hot parts to be cooled by freely flowing air, otherwise there is a risk of fire.

 Do not spin the pendant ! Spinning the pendant may result in breaking of the suspension cable and/or electrical malfunction!

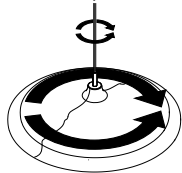

 For indoor use only. Installation requires 2 persons.

### 3/ Canopy disassembly

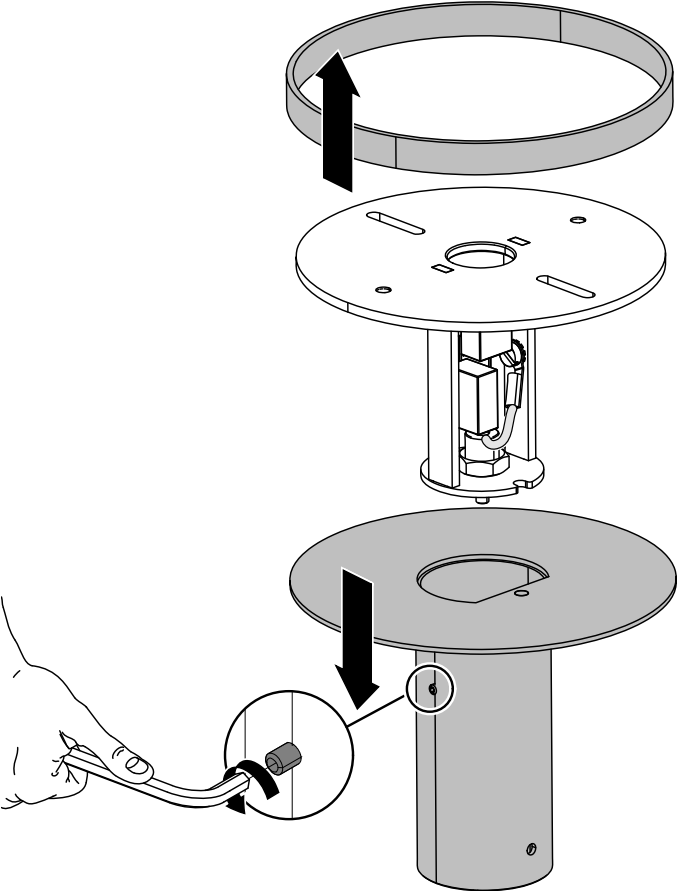

# 4/ Fixing point preparation

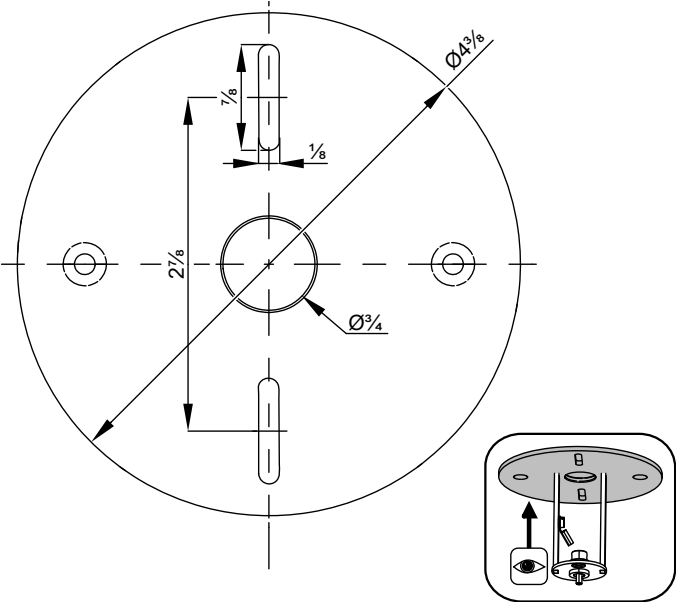



## 5/ Fixing (J-Box)

Fixing material is not included.

**!** Lasvit shall not be held liable for any injuries or damage to the fixture or other property caused during installation or by improper fixing. Consulting a specialist before choosing type of fixing materials and procedures for a given fixture is highly recommended.

Pictures shown are for illustration purposes only.

**!** First prepare a 4" J-Box with screws and PE cable (pos. 1), then you may proceed with the mount (pos. 2) installation.

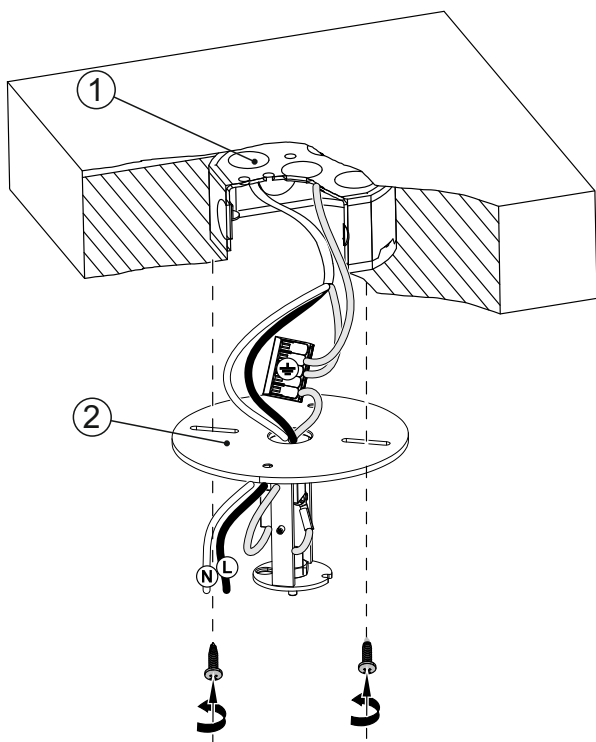

## 6/ Electrical wiring

 The bulb is already installed (pos D).

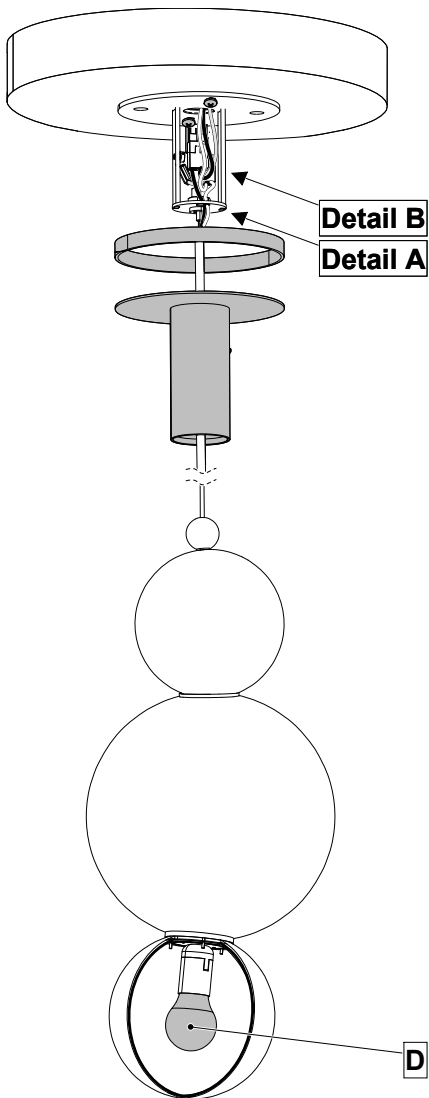

## 6.1/ Light source cable

### Detail A

Suspension cable securing the pendant (pos C).

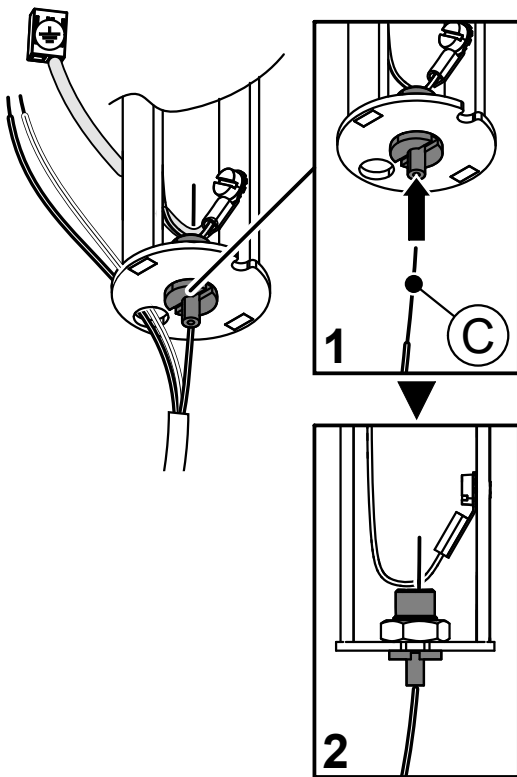

# 6.2/ Connection of mains input and light source output

Detail B

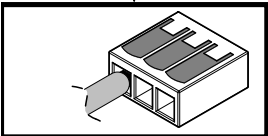
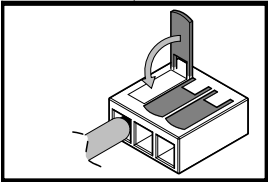
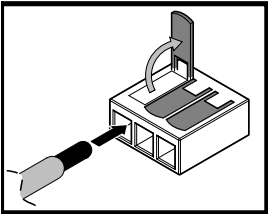
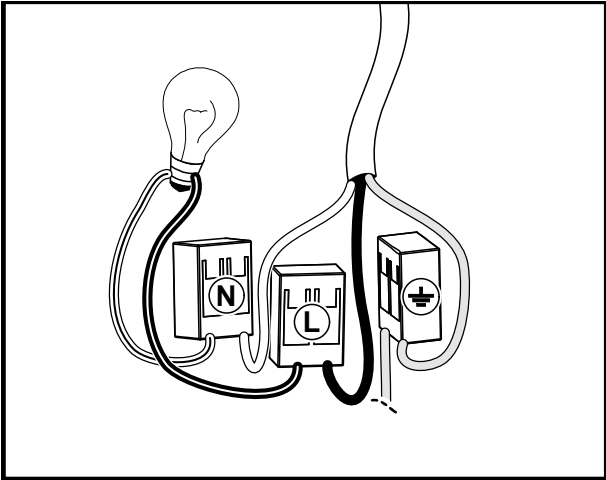

**7/ Canopy mounting**

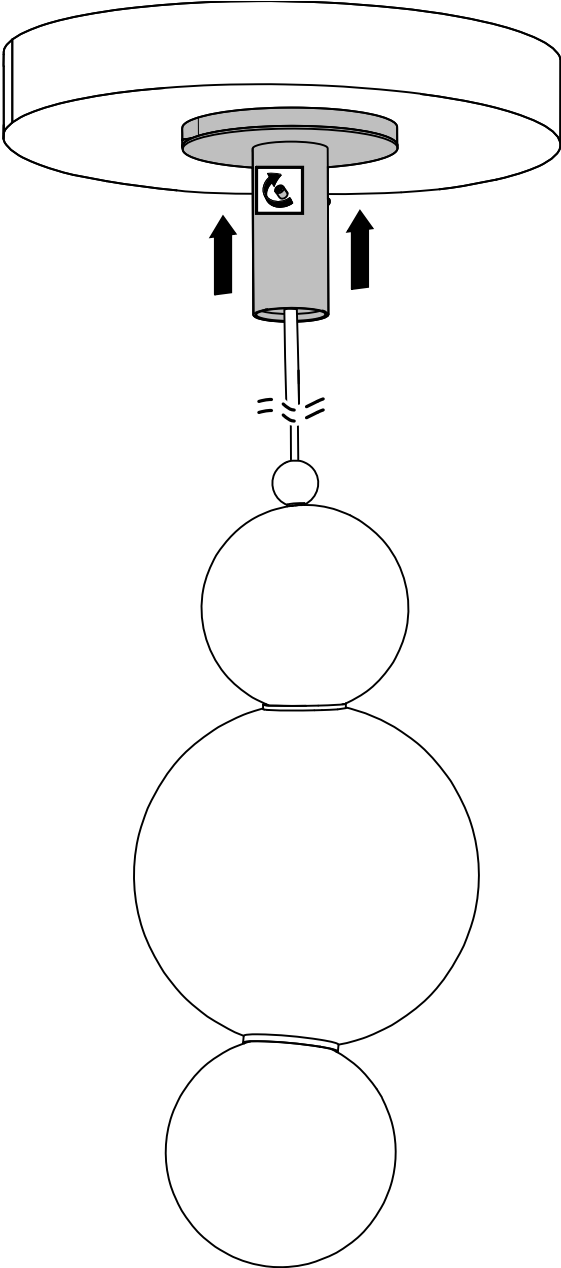

## **8/ Light source replacement**

All light sources can be supplied by the manufacturer, Lasvit s.r.o.

Replacement of the bulb should be carried out by qualified technician to prevent damage to health or property.

Lasvit provides NO warranty on bulbs and is not responsible for any damage or injury caused during its installation or during its operation.

Before starting installation make sure the power to the lighting fixture is switched OFF and secured against unauthorized, negligent or accidental switching on.

The manufacturer shall not be held responsible for injuries, damage to the fixture and/ or other property when other than specified light source type and/ or rating is used.

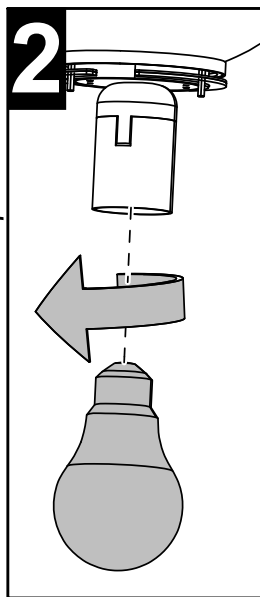
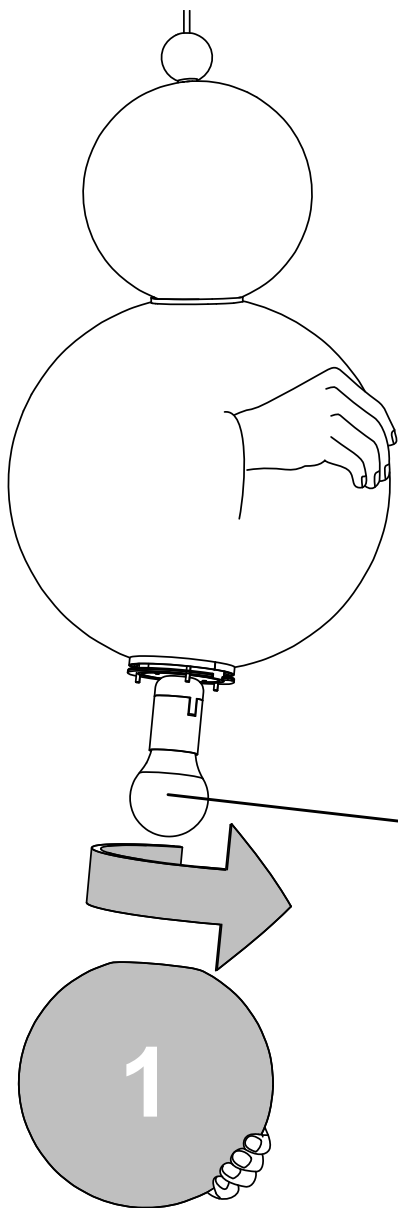

Carry out this step in reverse to fit the new bulb.

Plug in the light again.

## 9/ Installation notes

It's necessary to have minimal 25 mm overlap of the wire (position d) above the reutlinger (position c). The wire is marked (position e) for easier determine of minimal overlap. This is of the safety reasons.

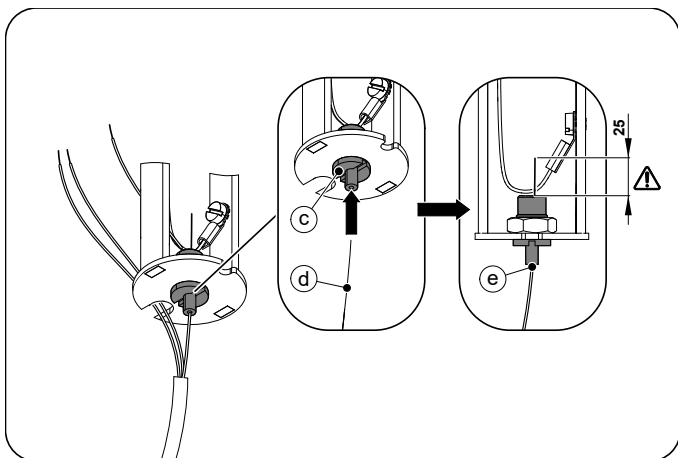



## 10/ Cable shortening

 This adjustment can be carried out only by a qualified electrician (trained electrician).

 Perform the cable adjustment according to valid standards.

**Picture 1:** Adjusted cable from the manufacturer (LASVIT).

**Picture 2:** Shortening the cable to the desired length.

**Picture 3:** Remove only the top insulation. The basic insulation of the conductor must not be broken.

**Picture 4:** Recognition of the support wire and the conductor. Conductors are marked with a color strip (positions A, B). The support wire is without marking. If you pull the wire into position C and, the cable returns to the position D, then this is a support wire. The conductor remains bent (positions A, B).

**Picture 5:** Remove the insulation from the support wire. In order to prevent the cable from slipping out of the wire holder (position E), the insulation from the support wire must be removed. Only the wire without insulation can be plugged into the wire holder. The length of the support wire must be the same as before its adjustment Picture 1. For a further description of the support wire, please refer to the manual.

**Picture 6:** Final adjustment of the cable for its connection. Additional insulation (positions F, G), stripped ends of wires with tubes and insulation removed from the support wire.

①

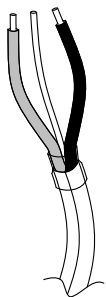

②

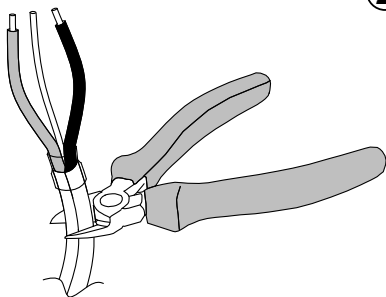

③

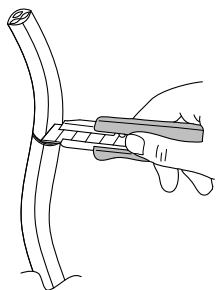

④

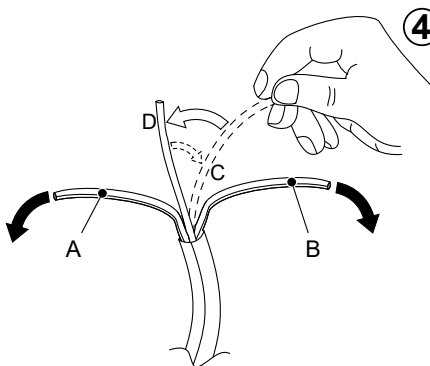

⑤

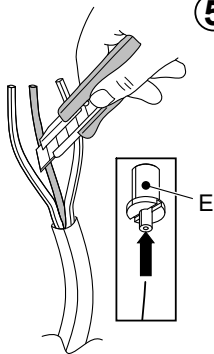

⑥

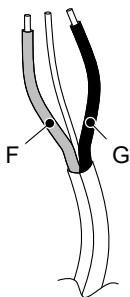

## 11/ Warranties and Warranty Terms and Conditions

1/ The warranty is defined in the Price Quotation, Price Agreement, Contract, or Order. If the Price Quote, contract, or order is not issued, the warranty does not apply to resources, maintenance, service and cleaning and the standard warranty on the goods is set for 2 years. Other agreed warranties must be specified in the Price Quotation, Price Agreement, Contract, or Order.

2/ As a basis for the claim, the customer must provide a valid contract, invoice, or other proof of payment. Otherwise, the manufacturer reserves the right to refuse to provide a warranty, so keep the proof of product purchase carefully.

3/ If the warranty applies to the defect found, the customer informs the seller by e-mail, telephone, or the Sales department of the manufacturer (Lasvit) and passes the required information (project number or light number, project or light name and describes the defect).

4/ The Sales Department proceeds on the basis of an internal customer complaint resolution directive.

5/ The manufacturer will analyse the occurrence of a disagreement with the customer or with the manufacturer after delivery of the non-conforming product to the manufacturer's premises.

6/ Once the analysis has been made, the Sales department is handed over the decision to accept or reject the complaint with an explanation.

7/ The Sales department agrees with the customer for further steps (e.g. repair or replacement date, etc. on the basis of customer and manufacturer possibilities). Unless otherwise agreed, the manufacturer is obliged to remove the defect within 30 days of the claim date at the manufacturer's expense.

8/ The warranty does not apply to:

- defects caused by the customer
- defects caused by a third party
- defects caused by regular usage
- defects caused by an installation contrary to the installation manual
- defects caused by inappropriate attachment or product connection
- defects caused by performed in contradiction with the cleaning manual

- defects caused by the use of other than defined light sources
- defects caused by installation in premises that do not correspond to the nature of the light and its IP cover (intrusion protection).
- defects caused by force majeure

9/ The company LASVIT has the exclusive right to grant, deny or change the terms and conditions for the provision of warranty services.





**Never dispose of this product in mixed municipal waste, it must be submitted at the designated disposal installation.**

The fixture was designed and manufactured by /  
Lasvit s.r.o. / Komunardů 32 / 170 00 Praha 7 /  
Czech Republic T +420 481 120 810 / F +420 481 120 622 /  
E lasvit@lasvit.com lasvit.com

**Manual created**

30.09.2021

In case you need any assistance or have any suggestion, please contact us at

**[lasvit.com](http://lasvit.com)**